



HOTE PROFESIONALE

Gama Block Seria 900



Utilizare/ aplicatie - bucatarii de restaurante, catering, cantine, fast-food
- captare, filtrare si extractie a grasimilor rezultate
in urma procesului de gatire a mancarurilor

Structura monobloc pentru lungimi mai mici de 2000 mm, pentru lungimi mai mari va fi asamblata prin module.

- material : inox AISI 304 cu finisaje satinat
- filtre antigrasimi tip labirint, format din lamele dispuse asimetric
- fatada port filtru din inox
- canal colector
- robinet de scurgere
- decupaje pentru racordarea tubulaturii cu hota cu diametre cuprinse intre 200-350 mm



Optional : - iluminare incastrata pe lungime
- ventilator exterior

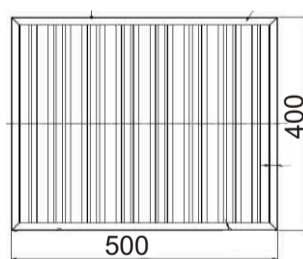
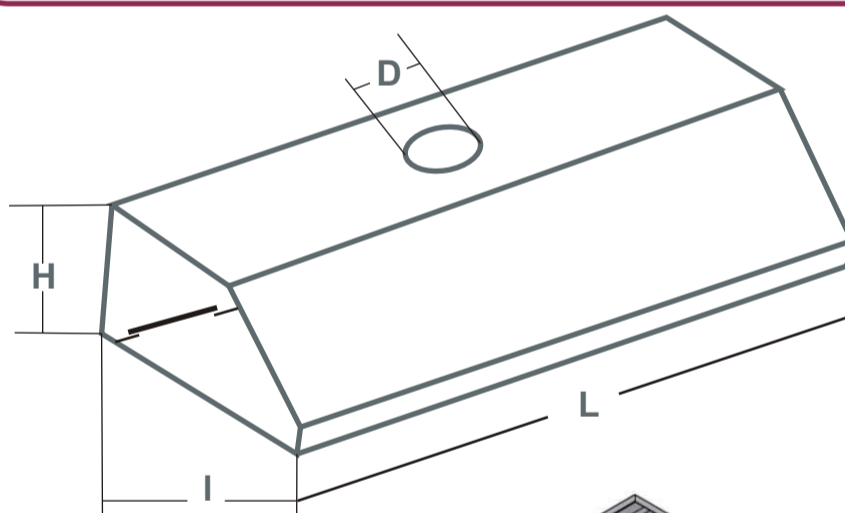

MODEL	DIMENS. mm				FILTRE	
	L	I	H	D	nr	mm
HBT9-10	1000	900	300	200	2	400 x 500
HBT9-12	1200	900	300	200	2	
HBT9-15	1500	900	300	200	3	
HBT9-20	2000	900	300	200	4	
HBT9-25	2500	900	300	250	5	
HBT9-30	3000	900	300	250	6	
HBT9-35	3500	900	300	300	7	
HBT9-40	4000	900	300	300	8	